





















- 1  M3\*35mm  
16 PCS
- 2  M5\*32mm  
8 PCS
- 3  M3.5\*35mm  
20 PCS
- 4  M3.5\*30mm  
8 PCS

- 5  M45\*45mm  
1 PC
- 6  Ø8\*40mm  
1 PC
- 7  M3.5\*50mm  
1 PC
- 8  M3\*16mm  
1 PC

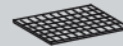
- A  2 PCS
- B  2 PCS
- C  2 PCS
- D  2 PCS
- E  4 PCS
- F  4 PCS
- G  2 PCS
- H  2 PCS
- I  1 PC
- J  1 PC
- K  1 PC
- L  1 PC

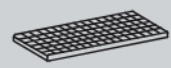
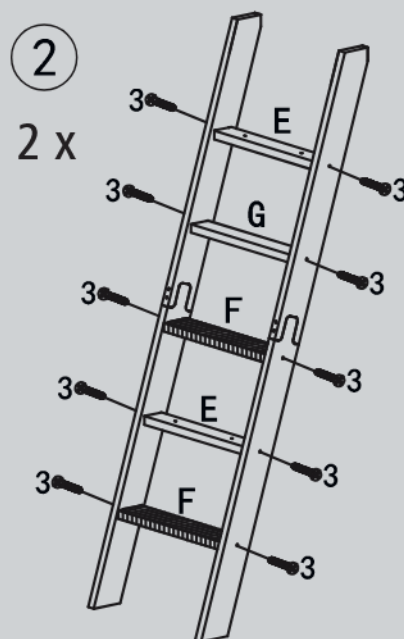
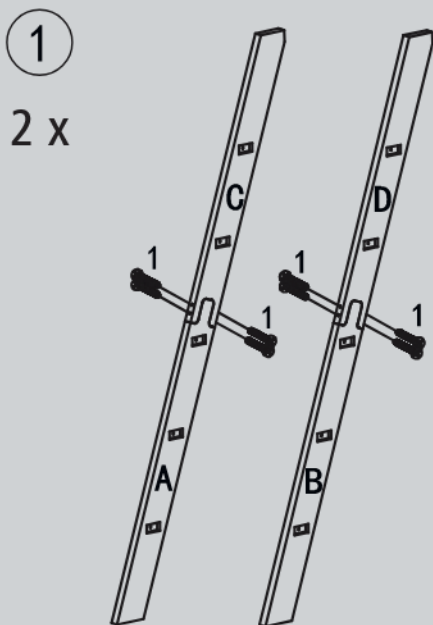

(DE) Bitte halten Sie die Reihenfolge der Arbeitsschritte 1,2,3,... von der Skizze ein.  
 (FR) Veuillez suivre la sequence du Workflow 1, 2, 3 ...comme vous pouvez le voir sur le schema.  
 (EN) Pls follow the sequence of the workflow 1,2,3,... as you can see on the draft.

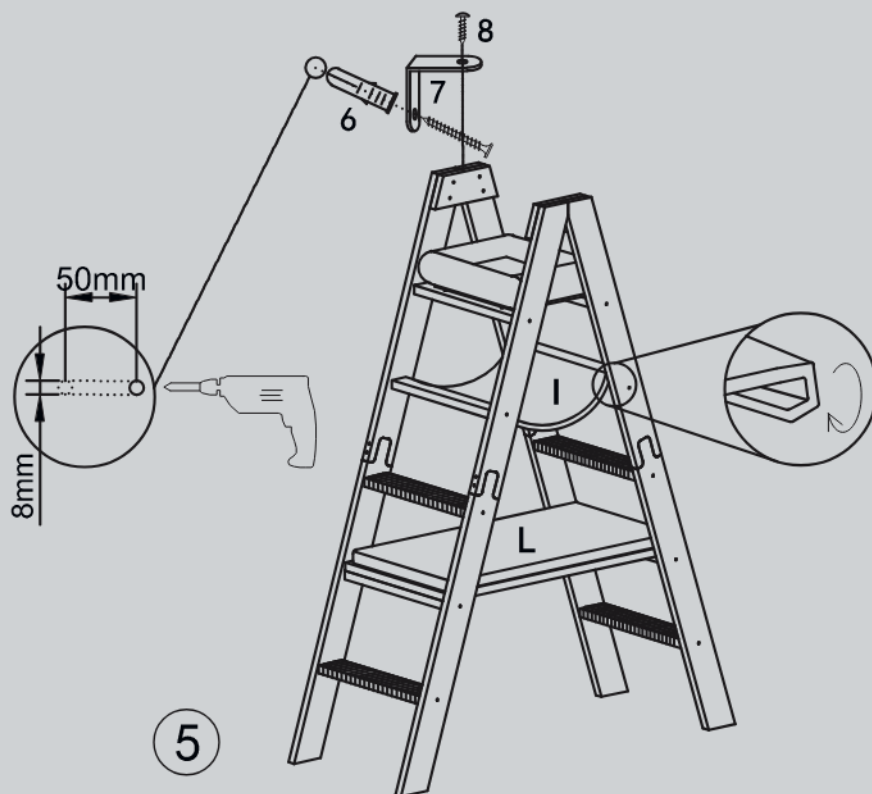
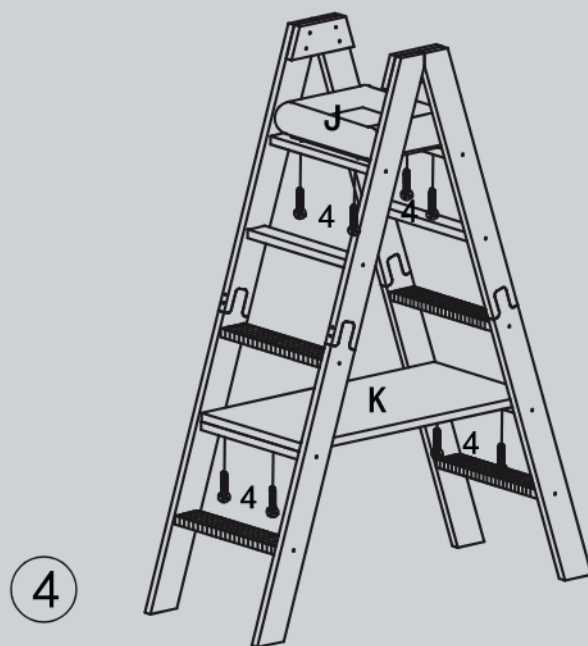
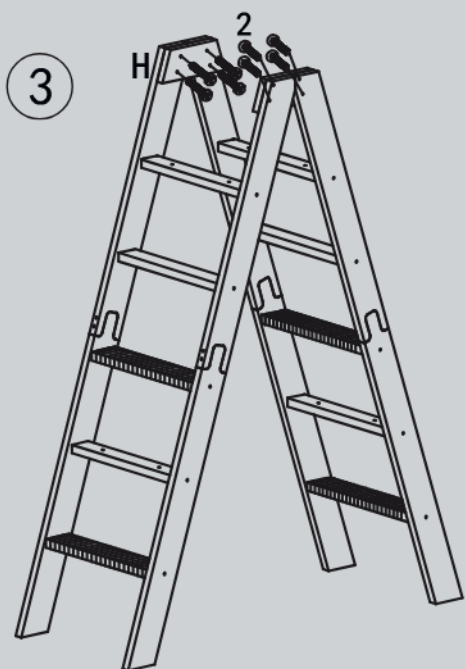
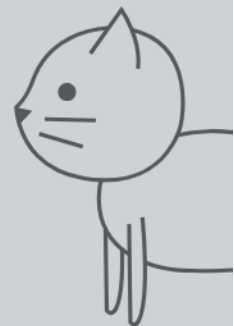

(DE) Bitte halten Sie die Reihenfolge der Arbeitsschritte 1,2,3,... von der Skizze ein.

(FR) Veuillez suivre la sequence du Workflow 1, 2, 3 ...comme vous pouvez le voir sur le schema.

(EN) Pls follow the sequence of the workflow 1,2,3,... as you can see on the draft.