













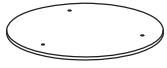
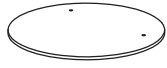





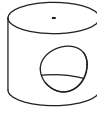

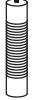

A	B	C	D			
						
M8*40mm 17PCS	M8*24mm 1PC	M8*80mm 8PCS	1PC			
1	2	3	4			
						
1PC	1PC	1PC	1PC			
5	6	7	8	9	10	
						
1PC	1PC	1PC	1PC	2PCS	2PCS	
11	12	13	14	15		
						
1PC	1PC	1PC	1PC	26cm 6PCS		
16	17	18	19	20	21	22
						
36cm 1PC	35cm 3PCS	30cm 1PC	40cm 1PC	40cm 3PCS	25.5cm 1PC	17.5cm 3PCS

(DE) Bitte halten Sie die Reihenfolge der Arbeitsschritte 1,2,3,... von der Skizze ein.

(FR) Veuillez suivre la sequence du Workflow 1, 2, 3 ...comme vous pouvez le voir sur le schema.

(EN) Pls follow the sequence of the workflow 1,2,3,... as you can see on the draft.

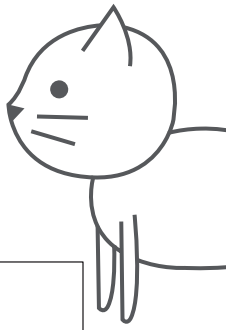

1

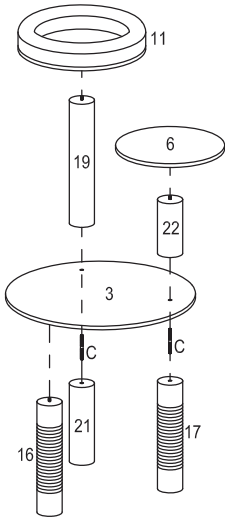

2

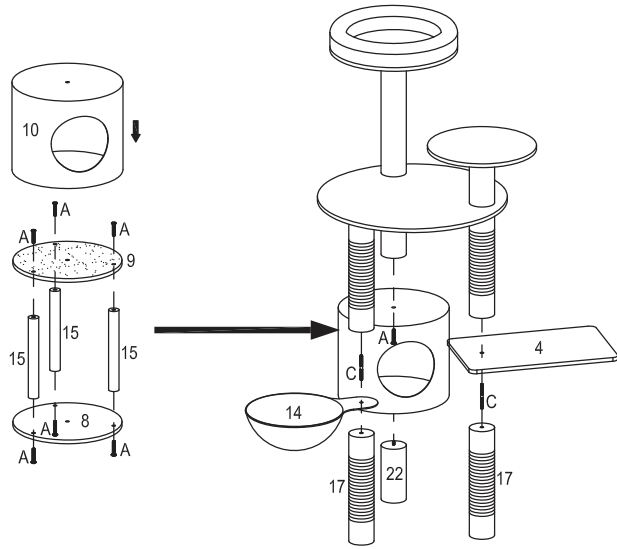

3

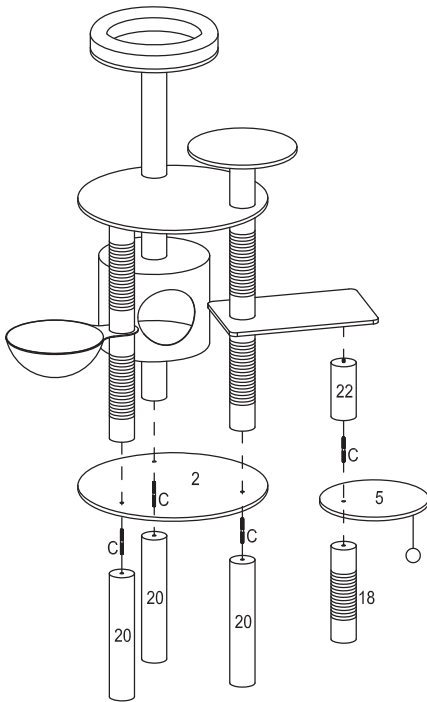

4

